

SMD thermal fuse for high currents

new



>210°C



>175°C



With Shunt

up to 60VDC · >175°C or >210°C · PCB, SMT

See below:

[Approvals and Compliances](#)

Description

- Patented surface mount thermal fuse to protect against thermal runaway of power semiconductors such as: MOSFET's, IC's, IGBT's, Triac's, SCR's, etc.
- Highest reliability thanks to complete galvanic separation.

Unique Selling Proposition

- Separates rated voltages up to 60 VDC
- Reflow compatible through mechanical activation procedure
- Galvanic separation happens inside the RTS housing
- Space-saving thanks to integrated shunt

Applications

- Wherever power transistors are used
- Automotive: Cooling fan applications, ABS power steering, PTC heaters, HVAC, Glow plugs, Diesel fuel heaters
- Industrial: Battery Protection, Power supplies, Lighting ballasts, H-Bridge circuits, Motor drivers

Other versions on request

- Thermal protection with integrated fuse
- Thermal protection with customer specific resistance
- Thermal protection with customer specific tripping temperature

References

Weblinks

[pdf data sheet](#), [html datasheet](#), [General Product Information](#), [Distributor-Stock-Check](#), [Detailed request for product](#), [Landing Page](#), [Video](#)

Technical Data

Rated Voltage	up to 60VDC
Breaking Capacity	up to 400A
Mounting	PCB, SMT
Tripping temperature	>175°C or >210°C
Material: Housing	Plastics
Material: Terminals	Copper alloy, tin-plated
Unit Weight	0.75 g
Storage Conditions	0°C to 40°C, max. 70% r.h.
Product Marking	Variant Code, Lot no.
Activation force	Fa = max. 50 N
Activation distance	Sa = 1.1 +0.3/-0.1 mm
Maximum reflow temperature	260°C (peak)

Soldering Methods	Reflow Soldering Profile
Solderability	JESD22-B102E, Method 1
Resistance to Soldering Heat	JEDEC J-STD-020
Moisture Sensitivity Level	MSL 1, J-STD-020
Damp heat, steady state	MIL-STD-202, Method 103
Thermal Shock	MIL-STD-202, Method 107
Operational Life	MIL-STD-202, Method 108 Condition D
Vibration, High Frequency	MIL-STD-202, Method 204 Condition D
Mechanical Shock	MIL-STD-202, Method 213 Condition B
Resistance to Solvents	MIL-STD-202, Method 215
Temperature Cycling	JESD22, Method JA-104 Condition G
Flame Retardance	AEC-Q200-001 + SAG Specification
Board Flex	AEC-Q200-005
Terminal Strength	AEC-Q200-006

Approvals and Compliances

Detailed information on product approvals, code requirements, usage instructions and detailed test conditions can be looked up in [Details about Approvals](#)

SCHURTER products are designed for use in industrial environments. They have approvals from independent testing bodies according to national and international standards. Products with specific characteristics and requirements such as required in the automotive sector according to IATF 16949, medical technology according to ISO 13485 or in the aerospace industry can be offered exclusively with customer-specific, individual agreements by SCHURTER.



Application standards

Application standards where the product can be used

Organization	Design	Standard	Description
	Suitable for applications acc.	IEC/UL 62368-1	Audio/video, information and communication technology equipment - Part 1: Safety requirements

Compliances

The product complies with following Guide Lines

Identification	Details	Initiator	Description
	RoHS	SCHURTER AG	Directive RoHS 2011/65/EU, Amendment (EU) 2015/863
	REACH	SCHURTER AG	On 1 June 2007, Regulation (EC) No 1907/2006 on the Registration, Evaluation, Authorization and Restriction of Chemicals 1 (abbreviated as "REACH") entered into force.
	Automotive	SCHURTER AG	AEC-Q200 is a test standard for passive components used in automotive applications. SCHURTER tests components according to the customer's agreement and is certified according to IATF 16949.

Dimension [mm]

Reflow soldering pads

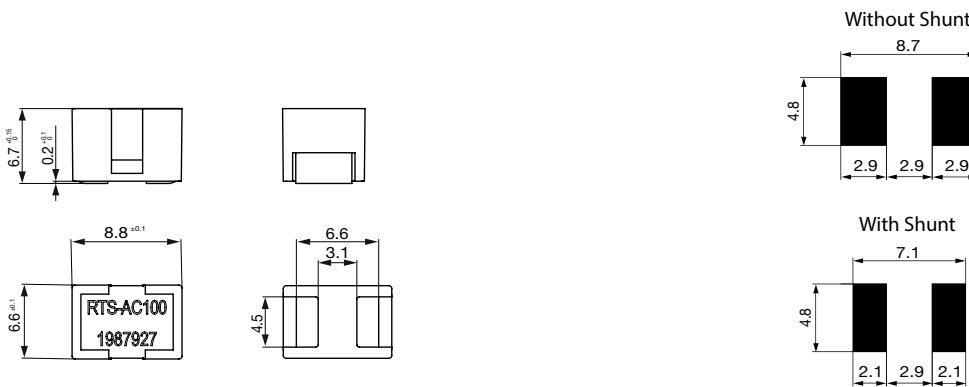

Activation status

Activation specification



Deactivated:
 Before reflow the activation button should not be manipulated with a force greater 5 newton.

Activated:
 Activation after reflow is necessary for the tripping functionality of the RTS. This activation is done by mechanically pressing the activation button with max 50 newton.

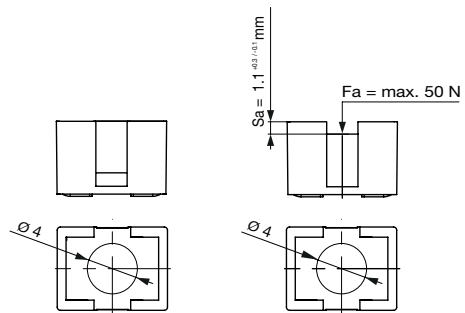

Diagrams

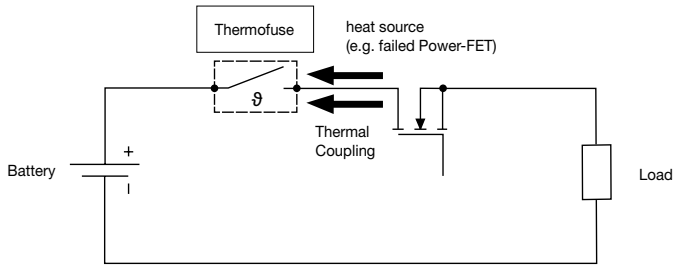

Derating Curves

Derating Curve without Shunt (RTS-AC100)

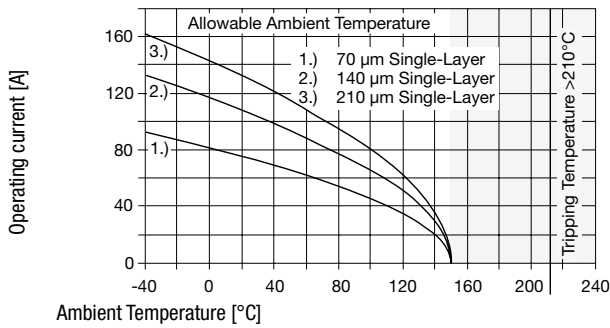

Derating Curve with Shunt (RTS-AS500)

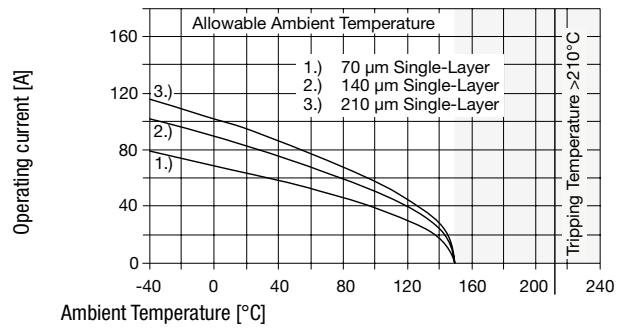

Derating Curve without Shunt (RTS-BC100)

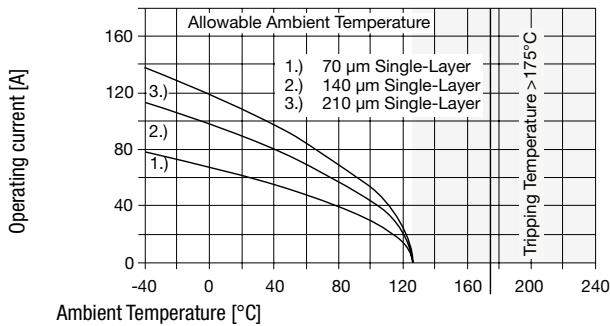

Derating Curve with Shunt (RTS-BS500)

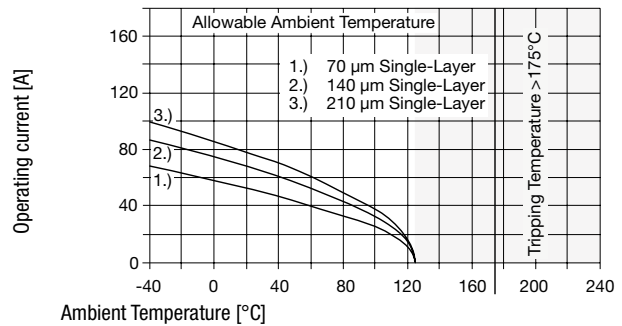

Design-In Principles

- > The RTS should be placed as close as possible to the heat source (power semiconductor).
- > Max. nominal current depends on ambient temperature and on the PCB track implementation (see Derating Curves).
- > The derating curves were generated using a PCB acc. to IEC 60127-4 with a layer width of 20 mm.
- > If operating current is higher than allowed, consider using two RTS in parallel. This doubles the max. current value in the derating curve.

Temperature Uniformity of Resistance

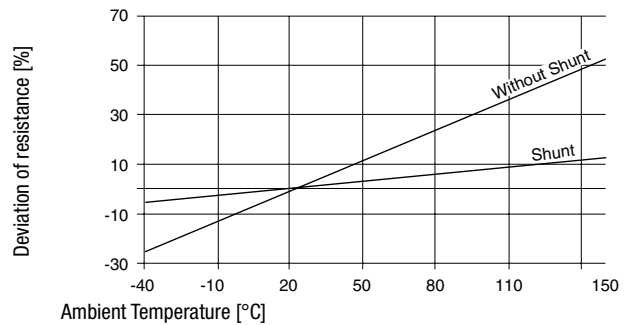

All Variants

Variant Code	Tripping temperature	Breaking Capacity	Shunt	Cold Resistance [$\mu\Omega$]	Allowable Operation Temperature	Packaging unit [PCS]	Order Number
RTS-AC100	>210°C	1)		90 - 110	-40°C to +150°C	100	3-104-513
RTS-AC100	>210°C	1)		90 - 110	-40°C to +150°C	750	3-104-514
RTS-AS500	>210°C	1)	●	500 - 580	-40°C to +150°C	100	3-119-589
RTS-AS500	>210°C	1)	●	500 - 580	-40°C to +150°C	750	3-119-590
RTS-BC100	>175°C	2)		90 - 110	-40°C to +125°C	100	3-134-780
RTS-BS500	>175°C	2)	●	500 - 580	-40°C to +125°C	100	3-134-804

Availability for all products can be searched real-time: <https://www.schurter.com/en/info-center/support-tools/stock-check-distributors>

1) Breaking Capacity: 400 A @ 24 VDC (L/R < 0.3ms) / 260 A @ 52 VDC (L/R < 0.2ms) / 170 A @ 60 VDC (L/R < 0.1ms)

2) Breaking Capacity: 400 A @ 24 VDC (L/R < 0.3ms)

Packaging Unit

acc. IEC 60286-3 Type 2a

100 pcs. in tape [W: 16mm and P1: 12mm] on reel [A: 18cm]

750 pcs. in tape [W: 16mm and P1: 12mm] on reel [A: 33cm]